

Inlet filter, front side mounting

Standard- or Medical-Filter



C14

 70° C



Description

- Panel Mount:
Snap-in or screw-on mounting from front side
- 2 Functions:
Inlet Protection class I, Line filter in standard and medical version
- Quick connect terminals 6.3 x 0.8 mm

Approvals

- VDE License Number: 117118
- UL License Number: E72928
- CSA License Number: 97784

Characteristics

- Ultra-compact design
- All single elements are already wired
- Qualified for use in equipment according IEC/EN 60950

Other versions on request

- Capacity CX 100 nF
- Medical version M80

References

[General Product Information](#)

Weblinks

[Approvals](#), [RoHS](#), [CHINA-RoHS](#), [e-Store](#), [SCHURTER-Stock-Check](#), [Distributor-Stock-Check](#)

Technical Data

Ratings IEC	1 - 10A @ Ta 40 °C / 250VAC; 50Hz	Appliance-Inlet /-Outlet	C14 acc. to IEC/EN 60320-1, UL 498, CSA C22.2 no. 42 (for cold condition) pin-temperature 70 °C, 10A, Protection class I
Ratings UL/CSA	1 - 15A @ Ta 40 °C / 125VAC; 60Hz	Line Filter	Standard and Medical Version, IEC 60939, IEC 60601-1, UL 1283, UL 544, EN 133 200, CSA C22.2 no. 8 Technical details
Leakage Current	standard < 0.5mA (250V / 60Hz) medical < 5 µA (250 V / 60 Hz)	MTBF	> 3'100'000h acc. to MIL-HB-217 F
Dielectric Strength	> 1.7kVDC between L-N > 2.7kVDC between L/N-PE Test voltage (2 sec)		
Allowable Operation Temp.	-25 °C to 85 °C		
Climatic Category	25/085/21 acc. to IEC 60068-1		
Degree of Protection	from front side IP 40 acc. to IEC 60529		
Protection Class	Suitable for appliances with protection class I acc. to IEC 61140		
Terminal	Quick connect terminals 6.3 x 0.8 mm		
Panel Thickness s	Screw-on: max 5 mm Mounting screw torque max 0.5Nm Snap-in: 0.8mm to 3mm		
Material: Housing	Thermoplastic, black, UL 94V-0		

Dimensions

Screw-on mounting

Length |-----| 55.6 mm

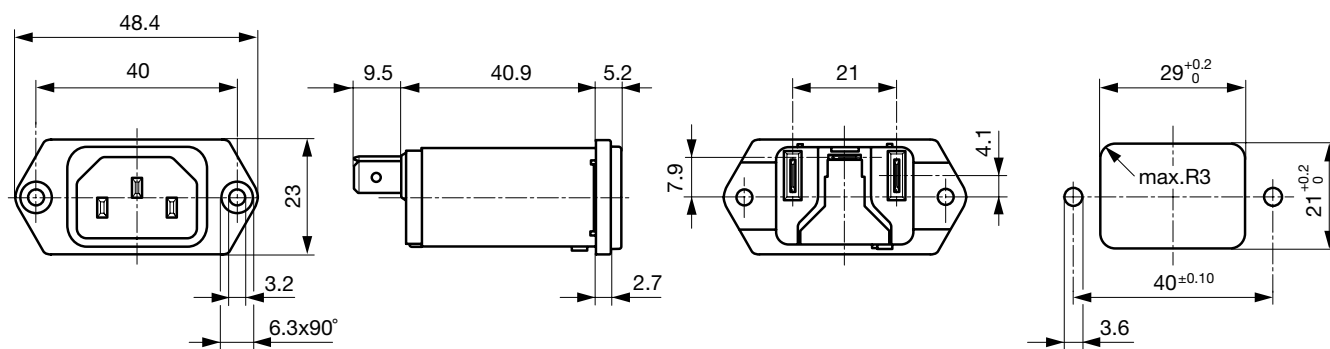

Snap-in mounting

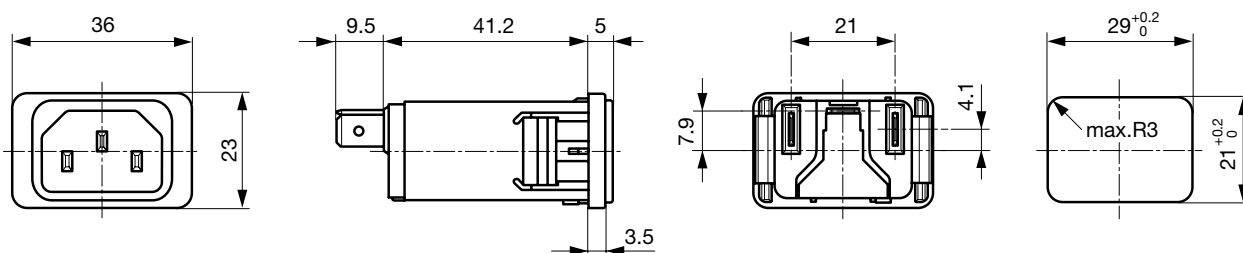
**Technical Data of Filter-Components**

Rated Current [A]	Filter-Type	Inductances L [mH]	Capacitance CX [nF]	Capacitance CY [nF]	R [MΩ]
1	Standard Version	2 x 11	47	2.2	-
2	Standard Version	2 x 4	47	2.2	-
3	Standard Version	2 x 2.5	47	2.2	-
4	Standard Version	2 x 1.6	47	2.2	-
6	Standard Version	2 x 0.7	47	2.2	-
8	Standard Version	2 x 0.6	47	2.2	-
10	Standard Version	2 x 0.4	47	2.2	-
15	Standard Version	2 x 0.1	47	2.2	-
1	Medical Version (M5)	2 x 11	47	-	1
2	Medical Version (M5)	2 x 4	47	-	1
3	Medical Version (M5)	2 x 2.5	47	-	1
4	Medical Version (M5)	2 x 1.6	47	-	1
6	Medical Version (M5)	2 x 0.7	47	-	1
8	Medical Version (M5)	2 x 0.6	47	-	1
10	Medical Version (M5)	2 x 0.4	47	-	1
15	Medical Version (M5)	2 x 0.1	47	-	1

Diagrams

Standard version

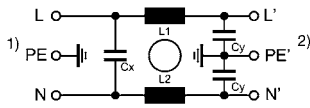

1) Line
2) Load

Medical version

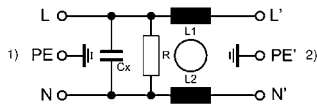

1) Line
2) Load

Attenuation Loss

--- differential mode ____ common mode

Standard version

1 A

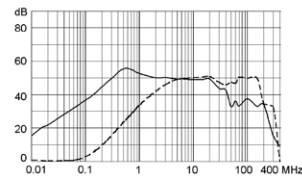

2 A

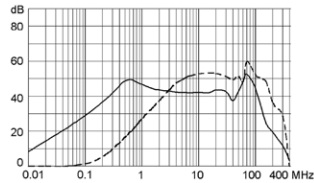

3 A

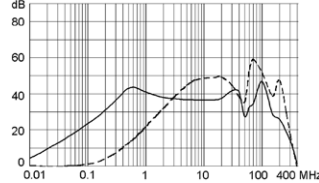

4 A

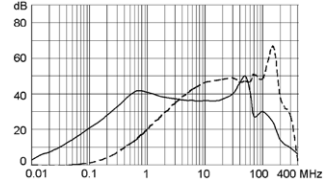

6 A

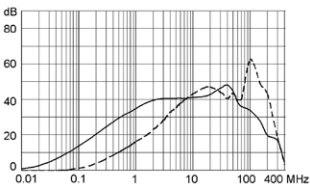

8 A

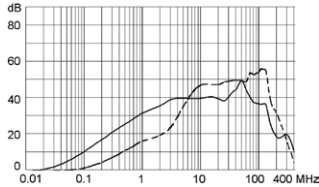

10 A

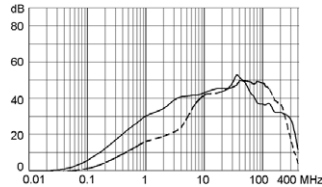

15 A

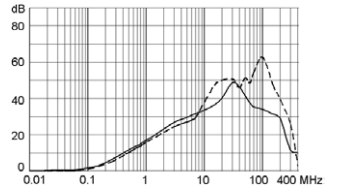

Medical version (M5)

1 A

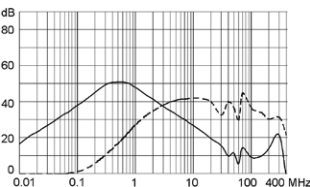

2 A

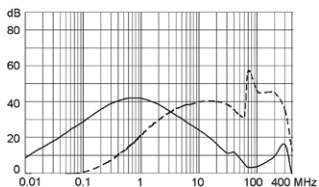

3 A

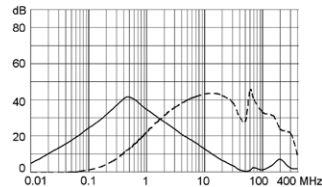

4 A

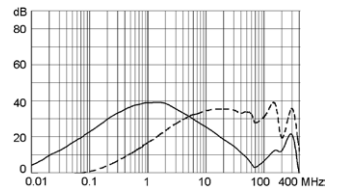

6 A

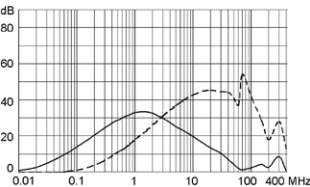

8 A

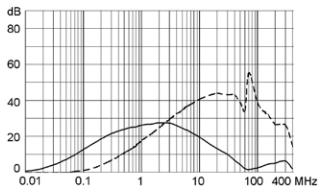

10 A

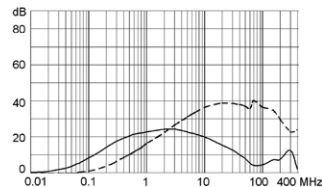

15 A

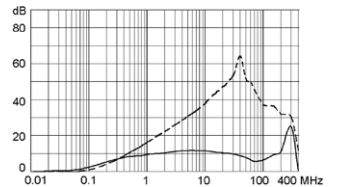

Distributor-Stock-Check | SCHURTER-Stock-Check | e-Store

Variants

Rated Current [A]	Filter-Type	Panel mounting	Order Number
1	Standard Version	Snap-in	5110.0143.1
2	Standard Version	Snap-in	5110.0243.1
3	Standard Version	Snap-in	5110.0343.1
4	Standard Version	Snap-in	5110.0443.1
6	Standard Version	Snap-in	5110.0643.1
8	Standard Version	Snap-in	5110.0843.1
10	Standard Version	Snap-in	5110.1043.1
15	Standard Version	Snap-in	5110.1543.1
1	Standard Version	Screw-on	5110.0133.1
2	Standard Version	Screw-on	5110.0233.1
3	Standard Version	Screw-on	5110.0333.1
4	Standard Version	Screw-on	5110.0433.1
6	Standard Version	Screw-on	5110.0633.1
8	Standard Version	Screw-on	5110.0833.1
10	Standard Version	Screw-on	5110.1033.1
15	Standard Version	Screw-on	5110.1533.1
1	Medical Version (M5)	Snap-in	5110.0143.3
2	Medical Version (M5)	Snap-in	5110.0243.3
3	Medical Version (M5)	Snap-in	5110.0343.3
4	Medical Version (M5)	Snap-in	5110.0443.3
6	Medical Version (M5)	Snap-in	5110.0643.3
8	Medical Version (M5)	Snap-in	5110.0843.3
10	Medical Version (M5)	Snap-in	5110.1043.3
15	Medical Version (M5)	Snap-in	5110.1543.3
1	Medical Version (M5)	Screw-on	5110.0133.3
2	Medical Version (M5)	Screw-on	5110.0233.3
3	Medical Version (M5)	Screw-on	5110.0333.3
4	Medical Version (M5)	Screw-on	5110.0433.3
6	Medical Version (M5)	Screw-on	5110.0633.3
8	Medical Version (M5)	Screw-on	5110.0833.3
10	Medical Version (M5)	Screw-on	5110.1033.3
15	Medical Version (M5)	Screw-on	5110.1533.3

Packaging unit 10 Pcs

Accessory

Description



Assorted Covers
Rear Cover

0859.0048



Cord retaining kits
Cord retaining strain relieve

Flat head, A

4700.0001

Countersunk, C

4700.0003